

# SPECIFICATION

Product Name: High installation sensor

---

Model No.: MC083S RC

---

Issue Date: July 10, 2023

---

CUSTOMER APPROVED

---

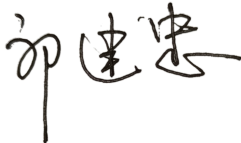
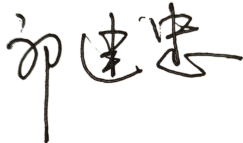
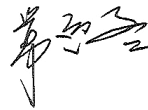
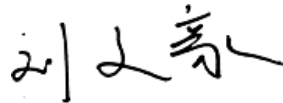
PRODUCT DIRECTOR APPROVED	P&M CHECKED	R&D CHECKED	PREPARED
			

## 1. Features

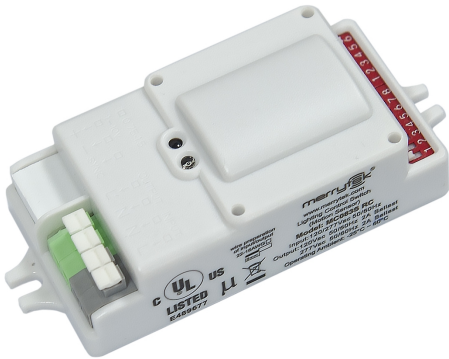

- High installation, can support 12m mounting
- users can configure each sense parameter according to needs.
- Support high-sensitivity and low-sensitivity mode (for metal ceiling, metal reflective surface installation environment)
- Override function
- 5 years warranty

## 2. Parameter

<b>Input</b>	Operating Voltage	108-305V AC 50/60Hz
	Rated Voltage	120/277V AC 50/60Hz
	Stand-by Power	≤1W
	Surge Test	L--N: 1kV
<b>Output</b>	Working Mode	ON/OFF function
	Type of Load	Inductive or resistive Load
	Load Capacity	2A @120Vac ,3A@277Vac, 3A@220-240Vac
	Max. Surge Capacity	30A (50%Ipeak,twidth =500uS, 230Vac full load, cold start); 60A (50% Ipeak, twidth=200uS, 230Vac, full load, cold start)
<b>Sensor Parameters</b>	Operating Frequency	5.8 GHz ±75 MHz, ISM Band.
	Transmitting power	0.5mW Max.
	Hold time	5S/30S/1min/3min/20min/30min
	Detection Area	100%/75%/50%/10%
	Daylight Sensor	5Lux/15Lux/30Lux/50Lux/100Lux/150Lux/Disable ( Ambient light diffusion )
	Detecting Radius	See detection pattern
	Mounting Height	12m Max
	Detecting Angle	150°
<b>Operating Environment</b>	Operating Temperature	-25℃...+60℃
	Storage Temperature	Temperature:-40℃...+80℃; Humidity:10%-95% (non-condensing)
<b>Certificate Standards</b>	Safety standards	EN61058-1, UL60703-1
	EMC standards	EN300440; EN301489-1; EN55015; EN61547; EN61000-3-2; EN61000-3-3; EN62479
	Environmental Requirement	Compliant to RoHS

<b>Certificate Standards</b>	Certificate	CE, RED,UL,FCC
<b>Others</b>	Input/output terminal specifications	Push-type terminal block; wire diameter: 0.75-1.5mm <sup>2</sup>
	IP Rating	IP20
	Protection Class	Class II
	Installation	Built-in installation
	Dimension	93.5*45*28.5mm
	Package	Bubble bag + partition + outer box (K=A)
	Net Weight	61.2g
	Lifetime	5 years warranty @Ta 230V full load

**Note**

1. "N/A" means not available.
2. Detection area is effected on volume of motion object and motion speed. The detection area is tested by a 165cm height person and walking speed is 0.5m/s.

### 3. Function

On/OFF Function

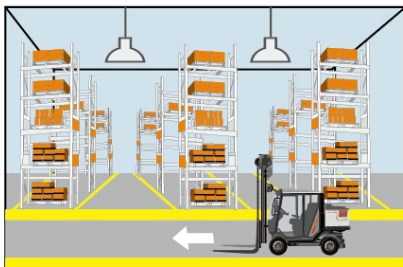

- 1 With sufficient ambient light, the light will not be switched on even if with motion signal.

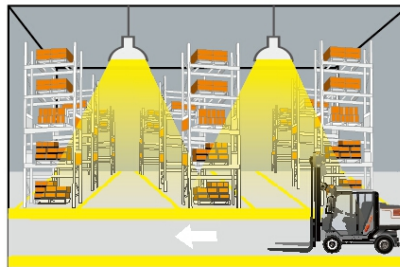

- 2 With insufficient ambient light, the sensor switches on the light when motion is detected.

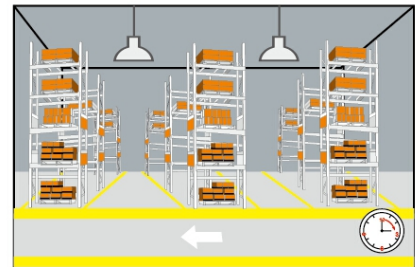

- 3 After elapse of hold time, the sensor switches off the light when no motion is detected.

#### 4. Dimension (mm)

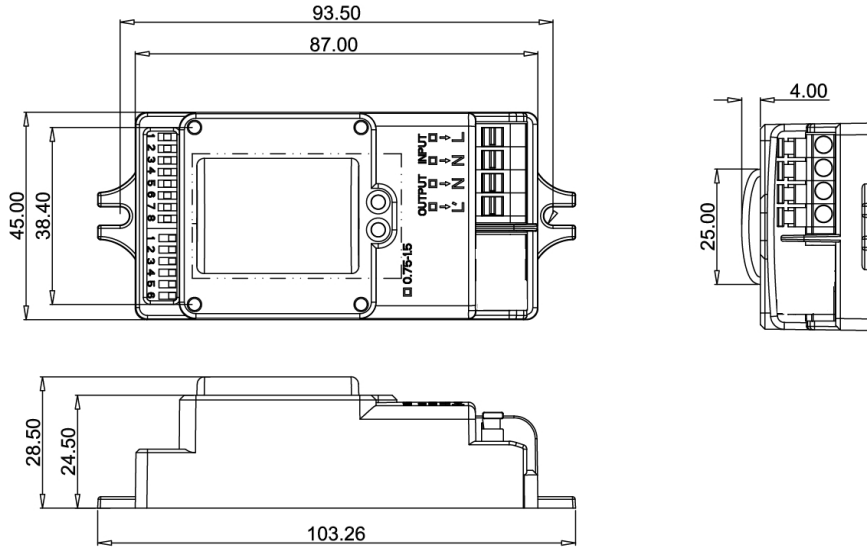

#### 5. Wiring

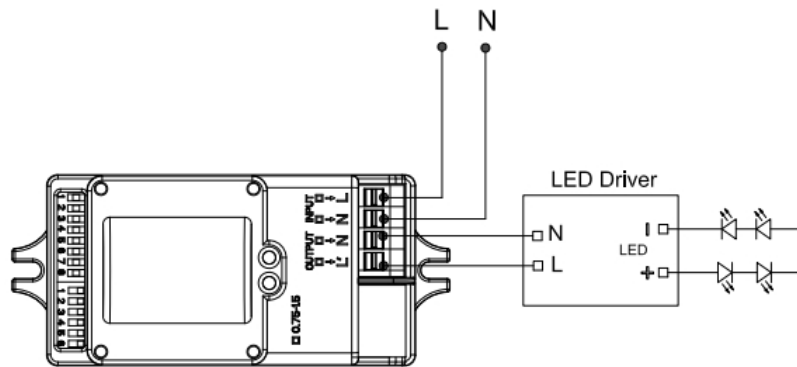

\*The sensor is designed to connect one load only. Connect more than one load may damage the sensor.

#### 6. Function Diagram

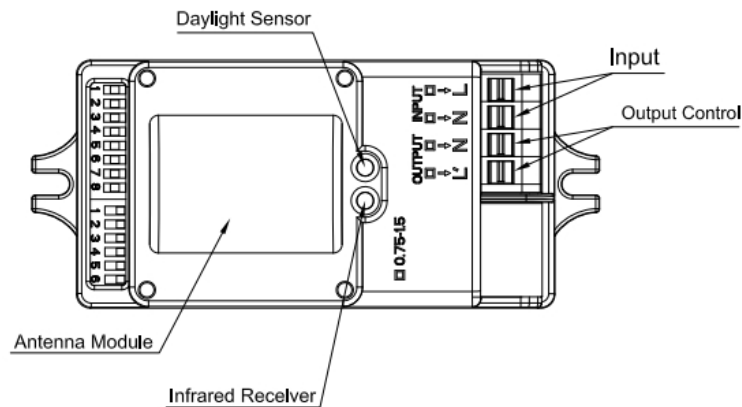

## 7. DIP Setting

### 1) Detection Area

	1	2	
I	ON	ON	100%
II	ON	-	75%
III	-	ON	50%
IV	-	-	10%

### 2) Hold Time

	3	4	5	
I	ON	ON	ON	5s
II	-	ON	ON	30s
III	ON	-	ON	1min
IV	-	-	ON	3min
V	ON	ON	-	20min
VI	-	-	-	30min

### 3) Daylight Sensor

	1	2	3	4	5	
I	ON	ON	ON	ON	ON	5lux
II	-	ON	ON	ON	ON	15lux
III	ON	-	ON	ON	ON	30lux
IV	ON	ON	-	ON	ON	50lux
V	ON	ON	ON	-	ON	100lux
VI	ON	ON	ON	ON	-	150lux
VII	-	-	-	-	-	Disable*

4) Detection mode

	6	
I	ON	HS
II	-	LS

8. Radiation Pattern

Ceiling mounting

Ceiling mounted  
height: 3m  
Sensitivity:  
100%/75%/50%

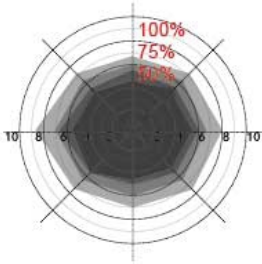

Ceiling mounted  
height: 6m  
Sensitivity:  
100%/75%/50%

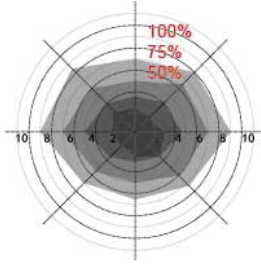

Ceiling mounted  
height: 9m  
Sensitivity:  
100%/75%/50%

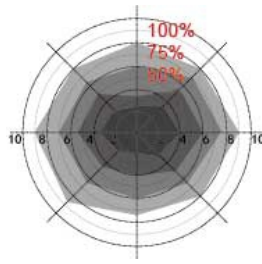

Ceiling mounted  
height: 12m\*  
Sensitivity:  
100%/75%/50%

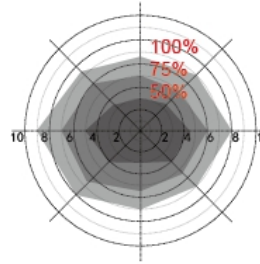

Ceiling mounted  
height: 15m\*  
Sensitivity:  
100%/75%

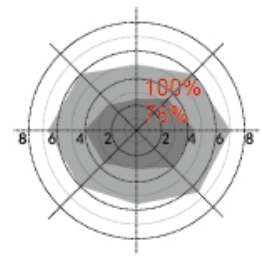

Normal moving  
(Speed:1m/s)

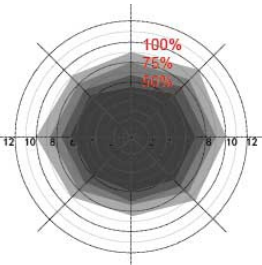

Normal moving  
(Speed:1m/s)

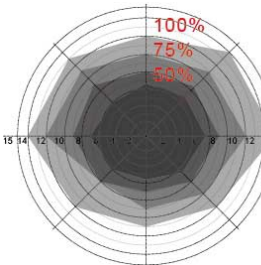

Normal moving  
(Speed:1m/s)

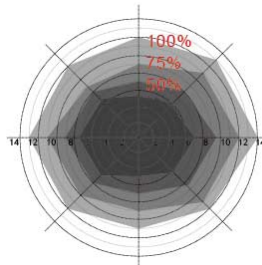

Normal moving  
(Speed:1m/s)

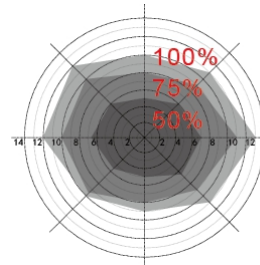

Normal moving  
(Speed:1m/s)

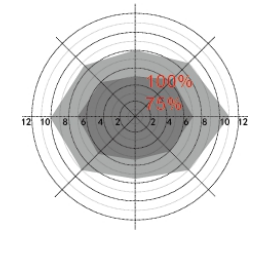

Slow moving  
(Speed 0.3m/s)

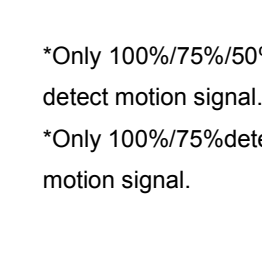

Slow moving  
(Speed: 0.3m/s)

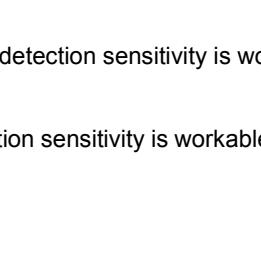

Slow moving  
(Speed: 0.3m/s)

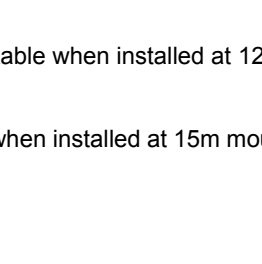

Slow moving  
(Speed: 0.3m/s)

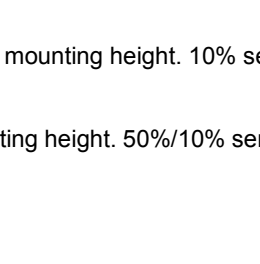

Slow moving  
(Speed: 0.3m/s)

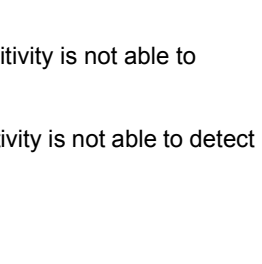

\*Only 100%/75%/50% detection sensitivity is workable when installed at 12m mounting height. 10% sensitivity is not able to detect motion signal.

\*Only 100%/75% detection sensitivity is workable when installed at 15m mounting height. 50%/10% sensitivity is not able to detect motion signal.

## Wall mounting

Horizon mounted height: 2m

Sensitivity: 100%/75%/50%

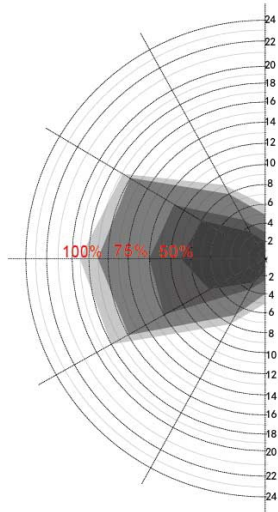

Normal moving (Speed: 1m/s)

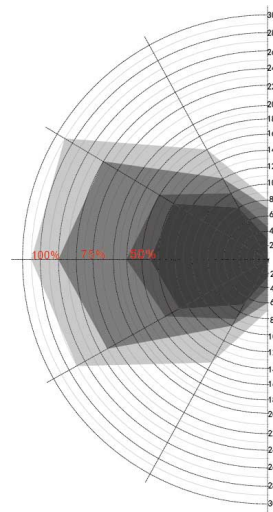

Slow moving (Speed 0.3m/s)

## 9. Initialization

On/Off function

After power on, the sensor automatically turns on light at 100% brightness. After 10sec, it turns off the light.

During the initialization, the sensor is not able to detect movement.

## 10. Factory Setting

Detection area: 100%, Hold Time: 5S, Daylight sensor: Disable, Detection mode: HS

## 11. Override Sensor

Power off, quick switch ON/OFF sensor 3 times (ON-OFF-ON-OFF-ON) within 2sec to override sensor function.

Lights will blink 3 times and then switch ON all the time. Power off and on again to recover sensor function.

## 12. Application Notice

- 1) The product can work with any kinds of control gear..
- 2) The sensor should be installed by a professional electrician. Please turn off the power before installing, wiring, changing the setting of the DIP switch.
- 3) The sensor mounted in a plastic, glass lampshade would reduce the sensitivity of the sensor. For every 3 mm increase in thickness, the sensitivity would reduce by 20%.
- 4) The sensing distance will be affected by the height of the sensor installation, the size of the object being detected, and the speed of movement.
- 5) Daylight the value is in a sunny environment with no shadows and ambient light diffuse reflection conditions. The values illumination detected by sensor may vary in different environment, at different times, in different seasons, and in different climates.
- 6) The parameters of the sensor may need to be reconfigured in different installation environments. Please refer to the following instructions or contact the manufacturer.
- 7) This sensor is for indoor use only. Outdoor use will affect the waterproof effect, wind and moving objects around would cause false triggering.
- 8) The distance between any inductive sensors should be greater than 3m.
- 9) When the sensor is installed in a metal illuminance , a metal reflective surface, or a narrow enclosed environment, the microwave will be reflected repeatedly and cause false triggering. Please reduce the sensitivity or contact the manufacturer for technical support.
- 10) Do not place the sensor close to high-density objects such as metal, glass, mixed-use walls, etc. The sensor may be triggered by mistake.
- 11) Please ensure that there are no moving signals around the sensor, such as fan, DC motor, sewer, air outlet, etc., the sensor may generate false triggers.